

# J5 60W 12V

BL Power

Standard LED Driver  
60W, Constant Voltage, 12VDC



J5 drivers are Class 2, UL Listed, constant voltage LED Drivers perfectly compatible with low-voltage lighting systems. With a universal 100-277VAC input voltage and available in a range of sizes that can power up to 180W over 3x60W output channels, these constant voltage, non-dimmable LED Drivers are enclosed in a low profile housing with integrated wiring compartments, making installation easy.

CLIENT	
PROJECT NAME	
LOCATION	
DATE	

## Product Detail



<b>Electrical</b>	Input Voltage	100-277VAC
	Input Frequency	50-60 Hz
	Max Input Current	0.9A
	Output Voltage	12VDC, Constant Voltage
	Power	60W
	Min. Power Draw	0W
	Dimming	Non-dimmable
	Max. Output Current	5.0A
	Connections	16 AWG, Copper Conductors
	Power Factor	0.94 - 0.99
<b>Mechanical</b>	Ambient Temperature	-40°F to 140°F (-40°C to 60°C)
	Max. Case Temperature	149°F (65°C)
	Circuit	Class 2
	Housing Construction	Anodized Aluminum
	Weight	2.4lb (1.1kg)
Environmental	IP65	

## Ordering

Product Code	Series	Power	Output	Input Voltage	IP Rating
J5ST	P	60W	12	UNI	IP65

## Dimensions

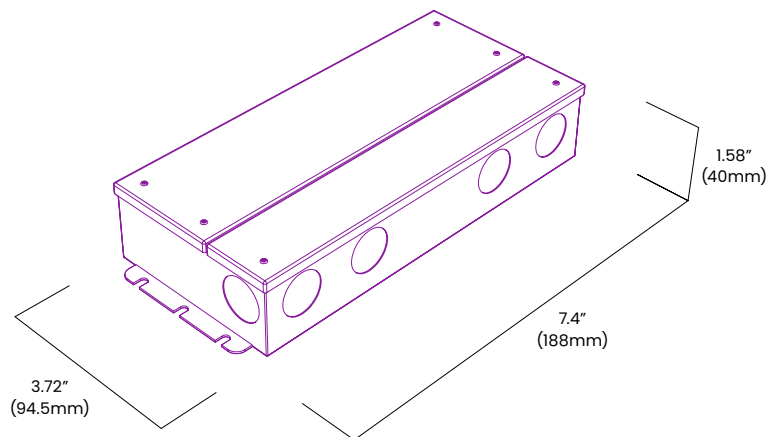

### BL LIGHTING ILLUMINATE EVERYTHING

111 - 8838 Heather St. Vancouver, BC, Canada. V6P 3S8  
P: 1-804-874-4405 E: info@bllighting.com  
Copyright © BL INNOVATIVE LIGHTING. All Rights Reserved.

Solid State Lighting is sensitive to power fluctuations. Surge protection is highly recommended for all LED lighting products and should be on a dedicated circuit to protect against premature failure. Lack of surge protection may void your warranty.

Designed & Assembled in North America.

Specifications subject to change without notice. Please refer to our website at bllighting.com for current technical data.

For more information, please download the BL LIGHTING catalog

[bllighting.com](http://bllighting.com)

