

## PRODUCT OVERVIEW

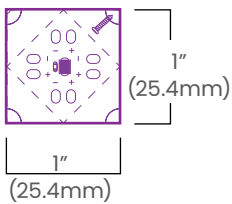
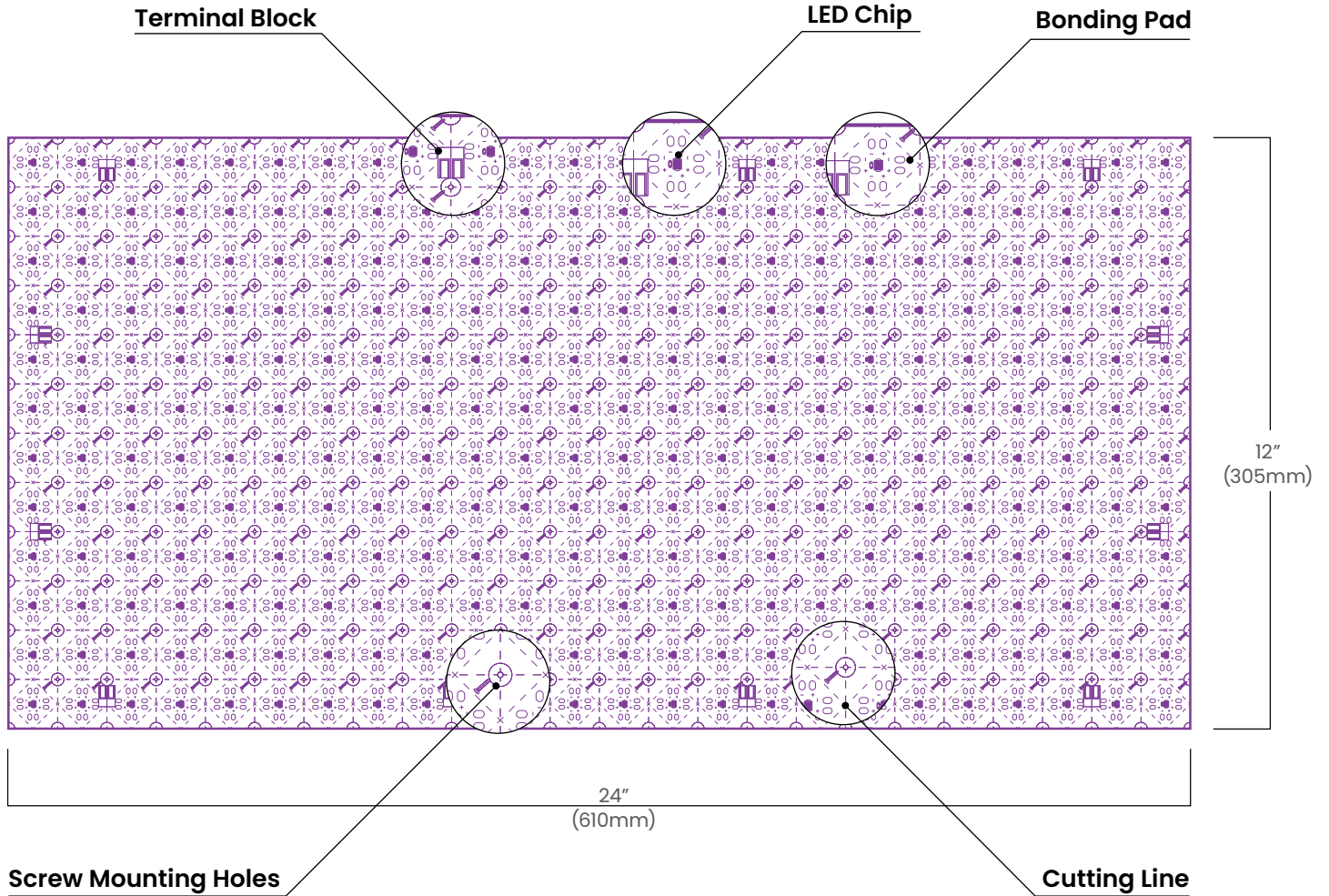

## CONNECTIONS

Between LED Sheets

### Connection Diagram

**NOTE:**

- Wiring colours may vary with each product. Follow label instructions.
- 18AWG Solid Core Wires are recommended.
- Please make sure the polarity of LED connections match by crossing jumper wires.
- Twist the power cord into the terminal block firmly until it could not be detached by hands.

**Power Cable**



To Power / LED Driver

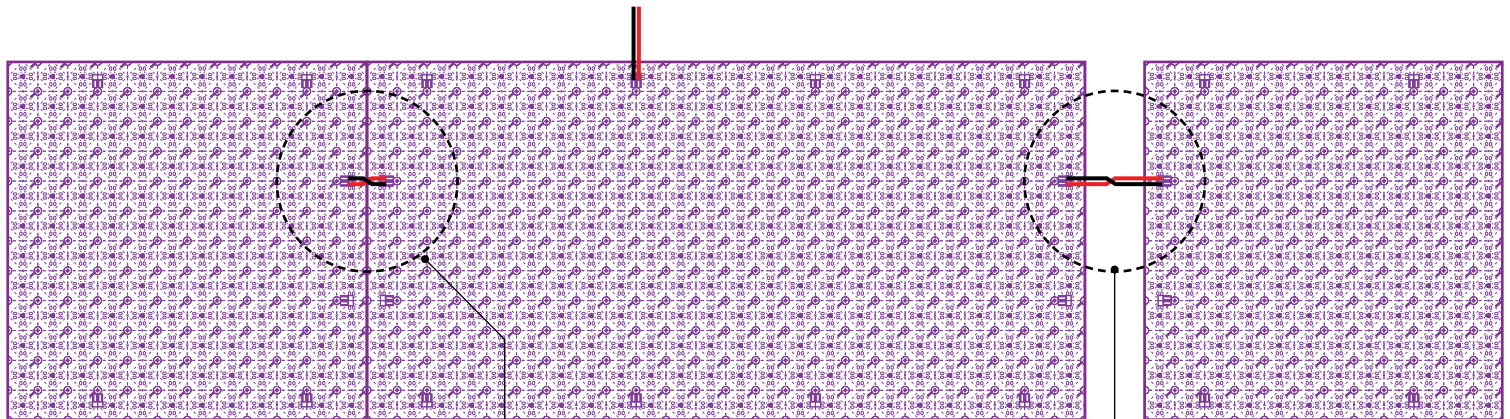

Side by Side Connection

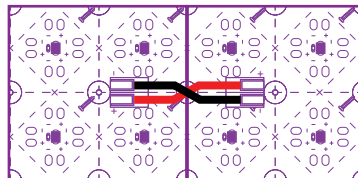

Sheet to Sheet Connection Power Cable

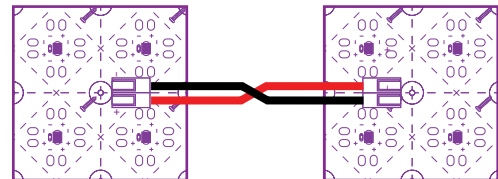

CONNECTIONS

Non-Dimming

Connection Diagram

NOTE:

- Wiring colours may vary with each product, follow the label instructions.

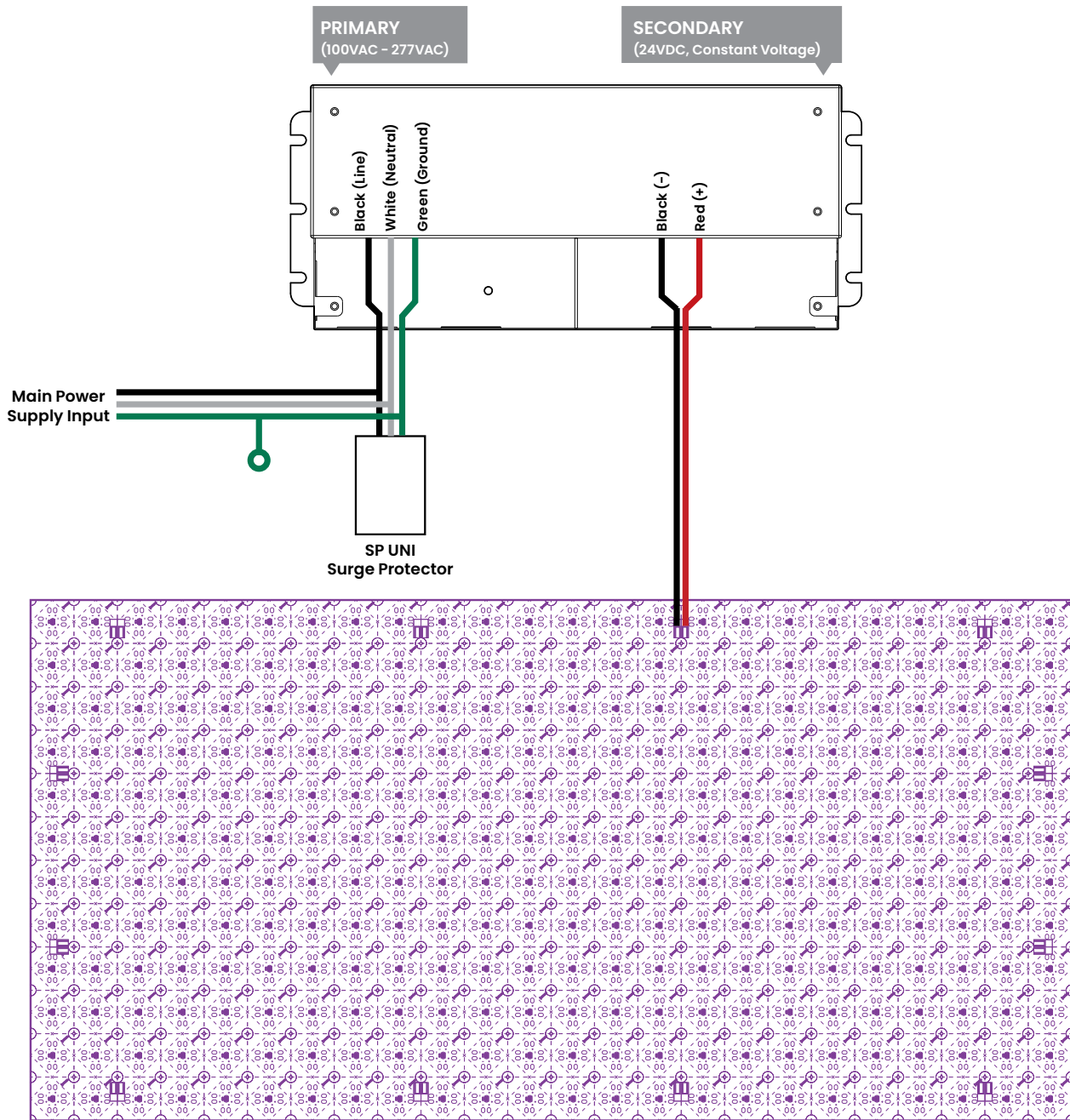

**CONNECTIONS**

0-10V

**Connection Diagram**

**NOTE:**

- Wiring colours may vary with each product, follow the label instructions.

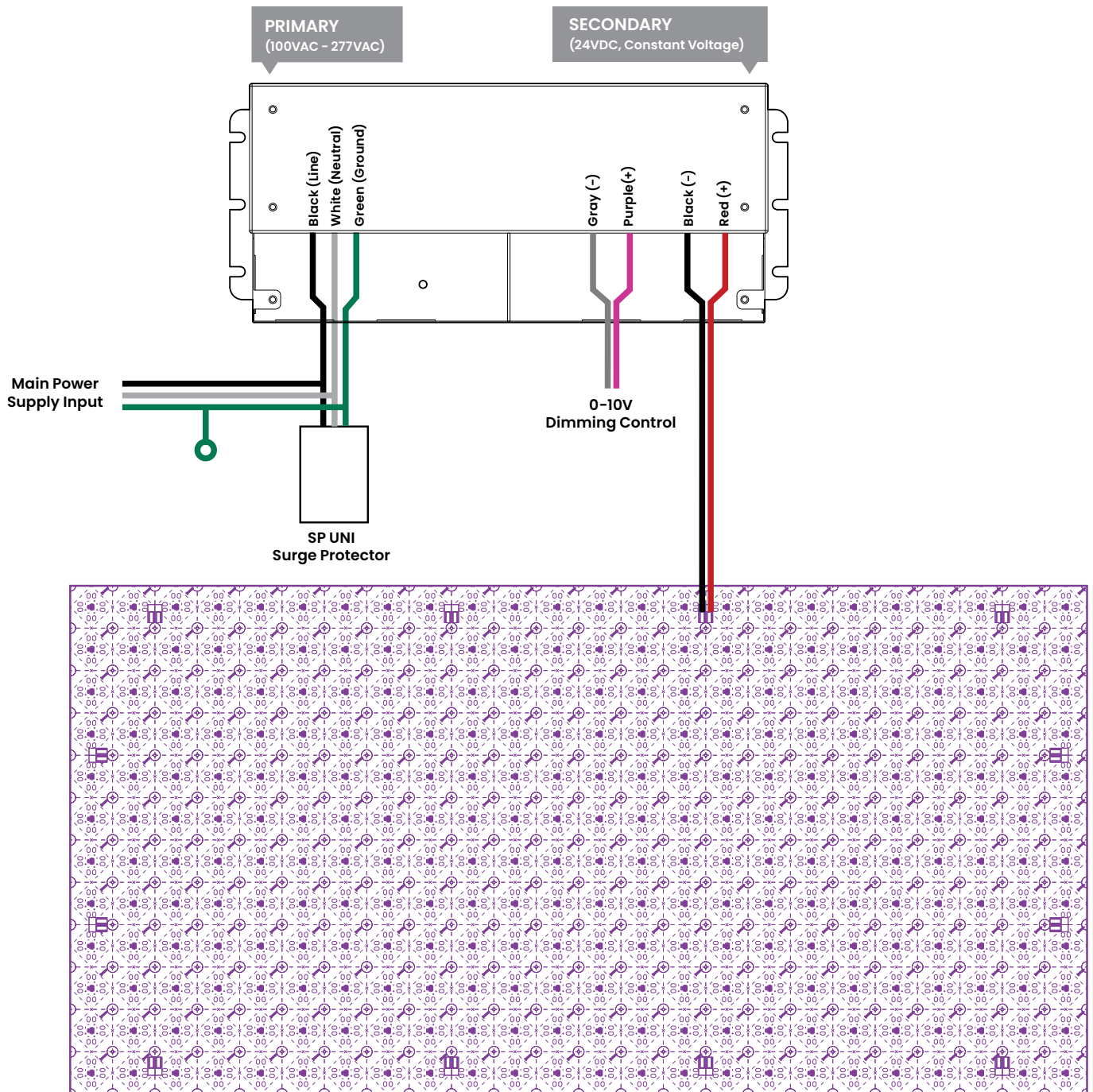

**CONNECTIONS**

Power and DMX

**Connection Diagram**

**NOTE:**

- Wiring colours may vary with each product. Follow label instructions.

