



Please note that these instructions are guidelines only and in no way supersede any construction or installation standards. Local building and electrical codes should be consulted before installation.

ATTENTION

- There is potential danger of electrical shock when operating electrical components.
- Make sure power is turned off before installation.
- Allow for heat dissipation and adequate ventilation.

SURFACE MOUNT
Mountable base with 180° Adjustable Bracket

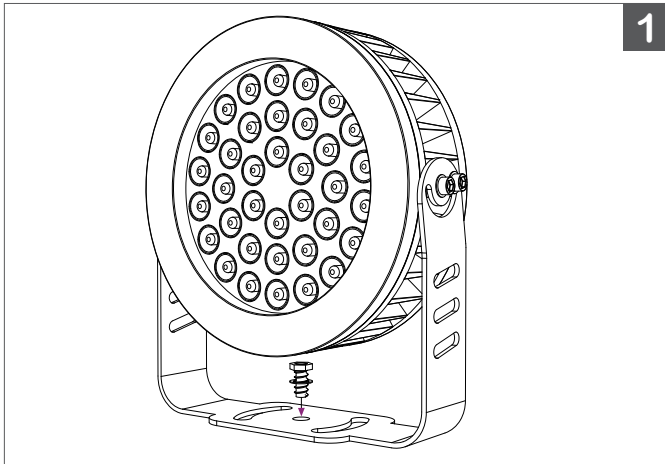

1.

- A. Position **CR212** at desired location of install.
- B. Fasten mounting bracket with bolts through mounting holes.

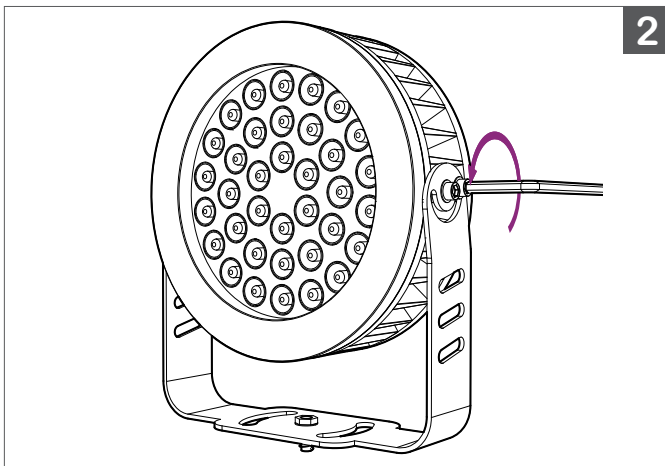

2.

Loosen screws with Hex Key.



SURFACE MOUNT
Mountable base with 180° Adjustable Bracket

3

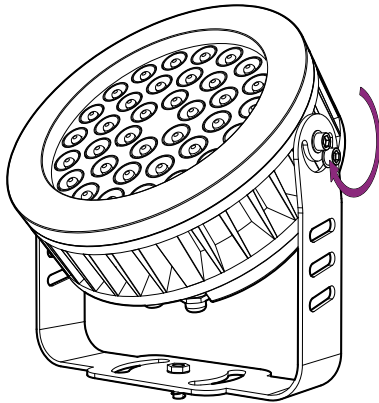

3.

Tilt **CR212** at desired angle.

4

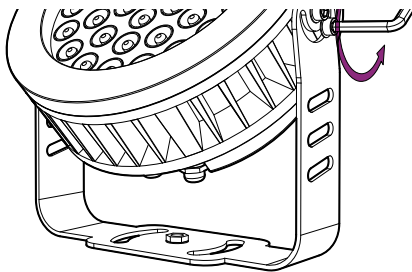

4.

Re-Tighten with Hex Key.

