

BL inGROUND

Square, Outdoor Recessed Luminaire
24VDC Constant Voltage

DISK S55

Printed



Please note that these instructions are guidelines only and in no way supersede any construction or installation standards.

Local building and electrical codes should be consulted before installation.

ATTENTION

- There is potential danger of electrical shock when operating electrical components.
- Make sure power is turned off before installation.
- Allow for heat dissipation and adequate ventilation.
- Fixture must be installed by a licensed Electrician and in accordance with all National and Local Electrical codes.

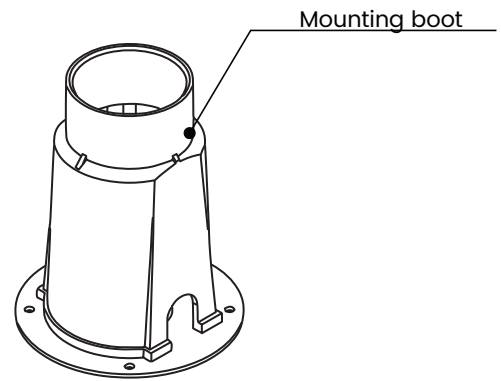
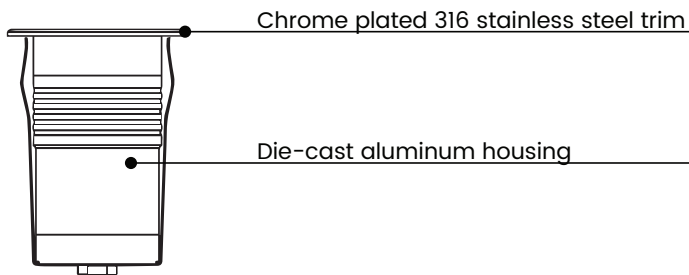

Power Supply/Driver Requirements

BL inGROUND DISK S55 operates on 24VDC; please check the voltage rating before starting. It is imperative that a regulated DC power supply is used and Class 2 is highly recommended. Refer to tables in the technical data pages for the power draw requirements. Surge protection is recommended for all applications in order to protect against premature failure. Consult the electrical code for details on mounting and installing power supplies/drivers. Please remember that 24V LED In-Ground light is a low voltage product and consult the appropriate section of the electrical code when selecting wire.



BL inGROUND

Square, Outdoor Recessed Luminaire
24VDC Constant Voltage

DISK S55

Printed



Connection Diagrams

Note:

- Wiring colours may vary with each product. Follow label instructions on the LED drivers
- Higher wattage LED drivers may have a third ground wire

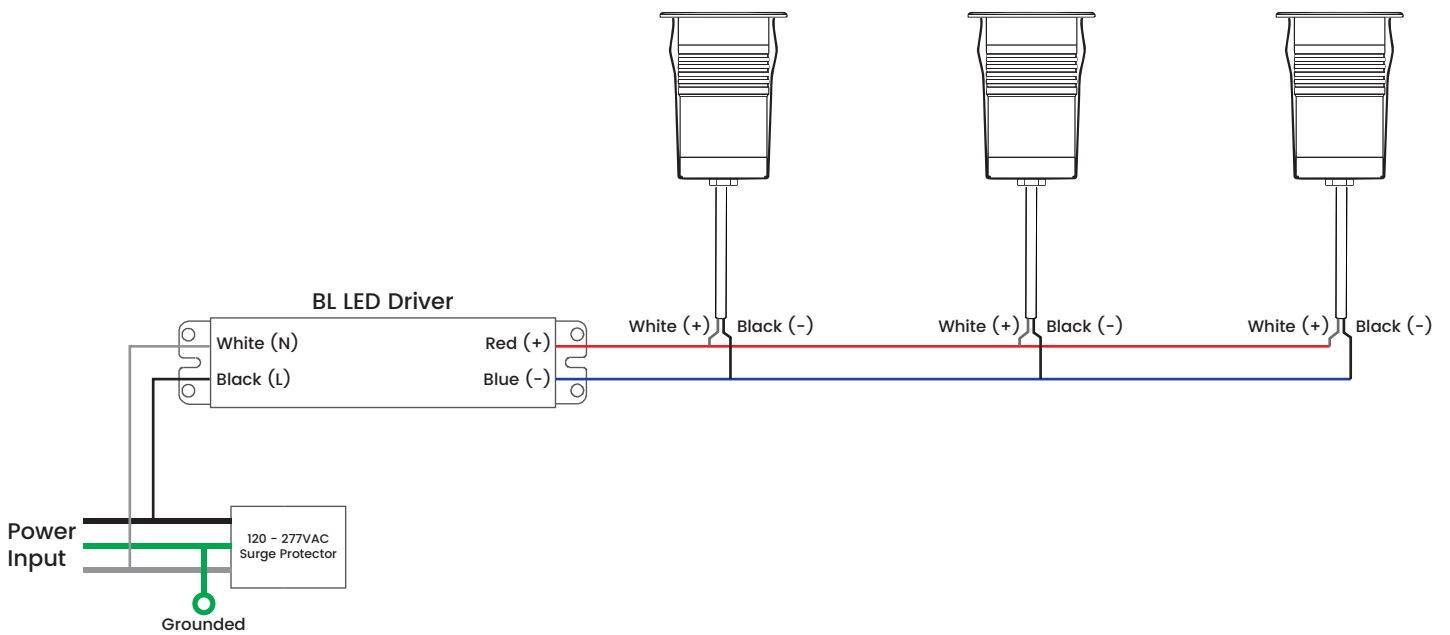

BL inGROUND

Square, Outdoor Recessed Luminaire
24VDC Constant Voltage

DISK S55

Printed



BL inGROUND DISK S55 is rated IP67 when installed in accordance with code and manufacturer instructions. All connections must be sealed to eliminate moisture seeping into the system.

The main housing base is powder coated aluminum, with a stainless steel chrome plated trim. Do not install near sea water, areas of high salt content, or high acidity.

Prepare soil, install mounting boot, install conduits, cables and install junction box.

- 1) Position mounting boot in location, ensuring mounting boot trim is level with surface, securing with stake if pouring concrete, and keep mounting boot clean and free of debris
- 2) Run conduit behind the boot and expand the conduit with an adapter
- 3) Pull the wiring through the conduit
- 4) Set the boot with solvent glue around the lipped circumference
- 5) Cut conduit even with the height of the substrate
- 6) Connect the lead wire – match colour as shown in the diagram and protect the end of the lead wire from water ingress (wire protection by others)
- 7) Slip the In-Ground light into the boot, using silicone around the under lip of the fixture to ensure a water tight fit
- 8) Tighten sleeve and light fixture with the provided surface screws.



BL inGROUND

Square, Outdoor Recessed Luminaire
24VDC Constant Voltage

DISK S55

Printed

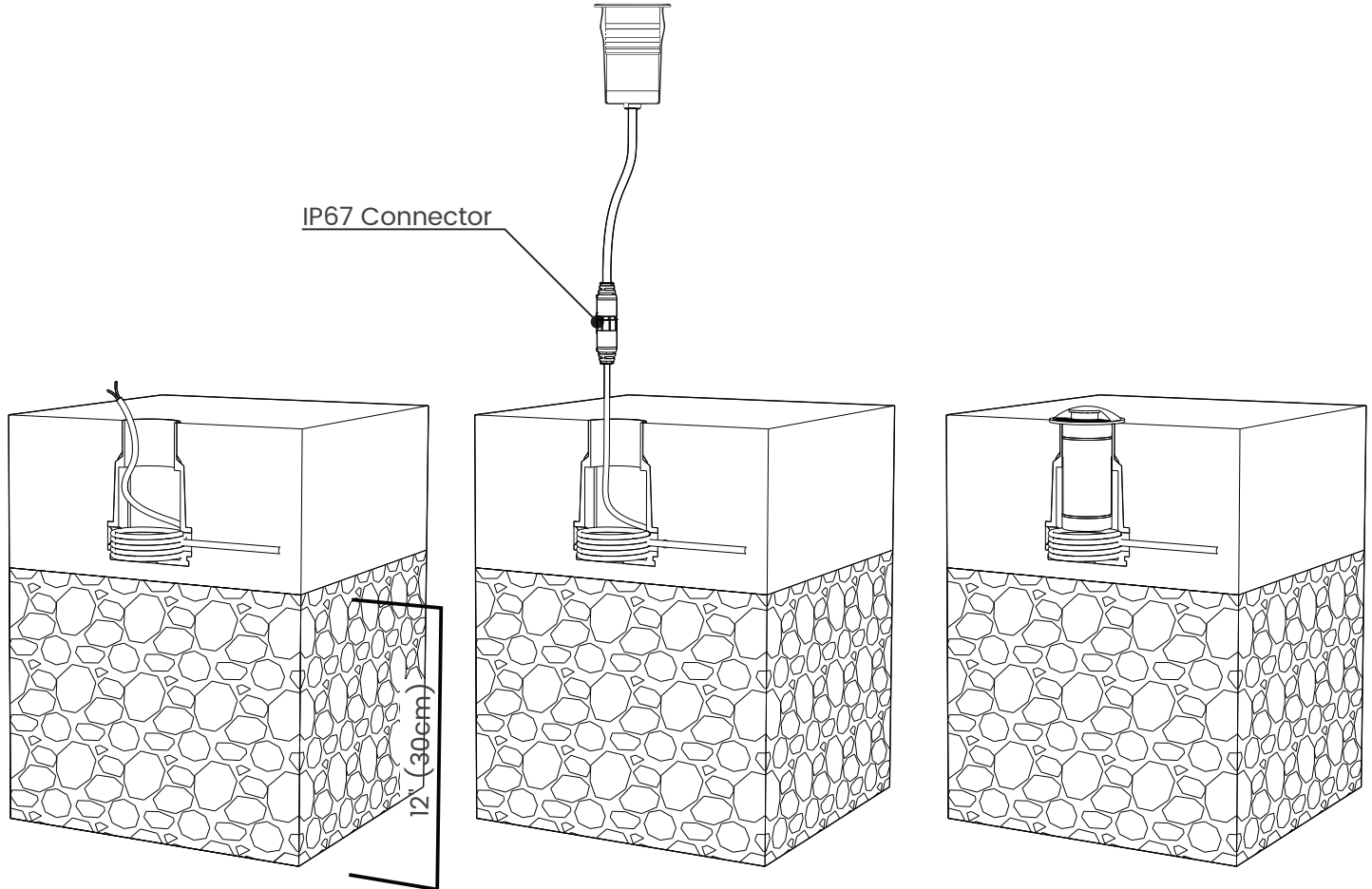

Prepare the ground, providing proper support for the mounting boot and install an adequate drainage system according to the application. Pipes may be installed in soft or hard ground to provide adequate drainage. For soft ground installations, drainage material such as pea gravel must be installed to a minimum depth of 12" (30cm). Minimum drainage rate 0.2Gal/min (0.75L/min) Luminaire should be installed only once adequate drainage is confirmed and mounting boot is dry and clean of debris.



BL inGROUND

Square, Outdoor Recessed Luminaire
24VDC Constant Voltage

DISK S55

Printed

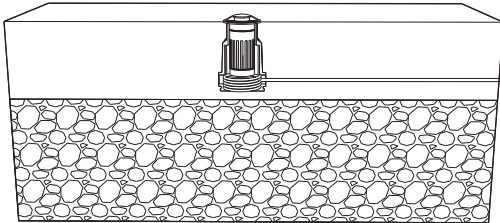

IK08 rated and designed to bear pressure loads up to 3700lbs (1700 kg), walk over only.

IP67 rated for water resistance. Not for permanent submersion. Luminaire must be installed according to all installation protocol. All connections must be appropriately sealed to eliminate moisture seeping into the system.

NOTE: When installing with metallic raceway or metallic cable sheath, a ground bushing listed for grounding must be connected between each conduit connection and the raceways shall be made electrically continuous by listed equipment bonding jumpers, or other means.

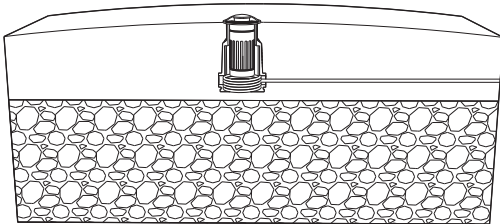

CAUTION: Bonding between the grounding bushing or between the grounding bushings and the equipment grounding terminal must be included as part of the installation procedure in accordance with the NEC/Canadian Electrical Code.

GROUNDING: Install the grounding conductor in accordance with requirements of the local Electrical Code.

