

BL LED Driver Phase Cut J5 60W

Dimming LED Driver (Phase Cut, ELV and MLV)
60W, Constant Voltage, 24VDC



Compatible with Phase Cut, ELV and MLV dimming protocols, the BL LED Driver Phase Cut J5 are UL Listed, Class 2, and have a universal 100-277VAC input voltage. Available in a range of sizes that can power up to 288W over 3x96W output channels, these constant voltage LED Drivers are enclosed in a low profile housing with integrated wiring compartments, making installation easy.

Quick Ship

CLIENT	
PROJECT NAME	
LOCATION	
DATE	

Product Detail



Electrical	Input Voltage	100-277VAC
	Input Frequency	47-63 Hz
	Max Input Current	0.9A
	Output Voltage	24VDC, Constant Voltage
	Power	60W
	Min. Power Draw	6W
	Dimming	Phase Cut, ELV, MLV
	Min. Dimming Level	0%
	Max. Output Current	2.5A
	Connections	18 AWG, Copper Conductors
Mechanical	Power Factor	0.95 - 0.98
	Ambient Temperature	-40°F to 140°F (-40°C to 60°C)
	Max. Case Temperature	149°F (65°C)
	Circuit	Class 2
	Housing Construction	Anodized Aluminum
	Weight	2.4lb (1.1kg)
	Environmental	IP65

Ordering

Product Code
BL LED DRIVER-Phase Cut-J5-60W

Dimensions

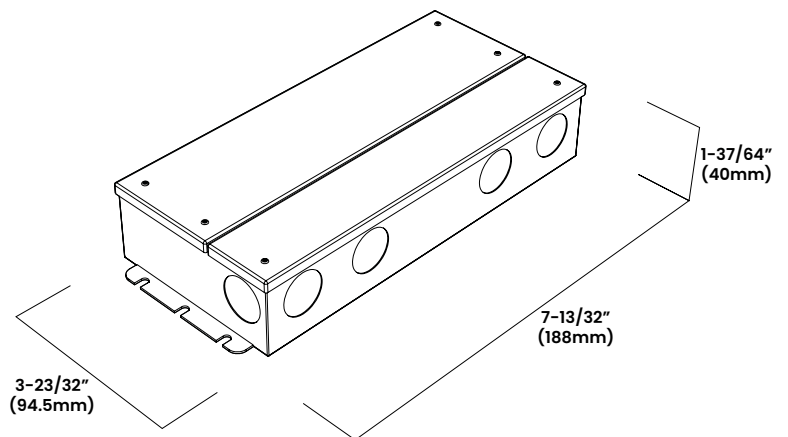

BL LIGHTING ILLUMINATE EVERYTHING

111 - 8838 Heather St. Vancouver, BC, Canada. V6P 3S8
P: 1-604-874-4405 E: info@bllighting.com
Copyright © BL INNOVATIVE LIGHTING. All Rights Reserved.

Solid State Lighting is sensitive to power fluctuations. Surge protection is highly recommended for all LED lighting products and should be on a dedicated circuit to protect against premature failure. Lack of surge protection may void your warranty.

Designed & Assembled in North America.

Specifications subject to change without notice. Please refer to our website at bllighting.com for current technical data.

For more information, please download the BL LIGHTING catalog

bllighting.com

