

BL LED Driver DALI J5 60W

Dimming LED Driver (DALI)
60W, Constant Voltage, 24VDC



Featuring DALI-2 dimming, the BL LED Driver DALI J5 are UL Listed, Class 2, and have a universal 100-277VAC input voltage. Available in 3 different sizes, 30W, 60W and 96W, these constant voltage LED Drivers are enclosed in a low profile housing with integrated wiring compartments, making installation easy.

Quick Ship

CLIENT	
PROJECT NAME	
LOCATION	
DATE	

Product Detail



Electrical

Input Voltage	100-277VAC
Input Frequency	47-63 Hz
Max Input Current	0.9A
Output Voltage	24VDC, Constant Voltage
Power	60W
Min. Power Draw	1W
Dimming	DALI
Min. Dimming Level	0%
Max. Output Current	2.5A
Connections	18 AWG, Copper Conductors
Power Factor	0.95 - 0.99
Ambient Temperature	-40°F to 122°F (-40°C to 50°C)
Max. Case Temperature	131°F (55°C)
Circuit	Class 2

Mechanical

Housing Construction	Anodized Aluminum
Weight	2.4lb (1.08kg)
Environmental	IP65
THD	<15%

Ordering

Product Code
BL LED DRIVER-DALI-J5-60W

Dimensions

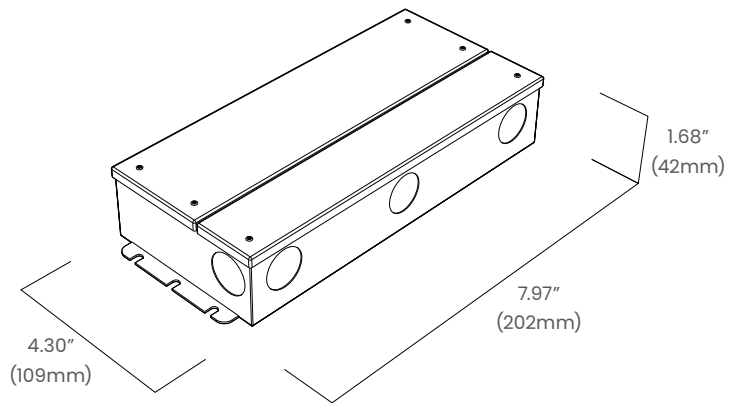

BL LIGHTING ILLUMINATE EVERYTHING

111 - 8838 Heather St. Vancouver, BC, Canada. V6P 3S8
P: 1-604-874-4405 E: info@bllighting.com
Copyright © BL INNOVATIVE LIGHTING. All Rights Reserved.

Solid State Lighting is sensitive to power fluctuations. Surge protection is highly recommended for all LED lighting products and should be on a dedicated circuit to protect against premature failure. Lack of surge protection may void your warranty.

Designed & Assembled in North America.

Specifications subject to change without notice. Please refer to our website at bllighting.com for current technical data.

For more information, please download the BL LIGHTING catalog

bllighting.com

