

BL LED DRIVER TRIAC J5

Dimming LED Driver (TRIAC, MLV and ELV)
3 x 96W, Constant Voltage, 24VDC

3 x 96W

Printed

Dimensions

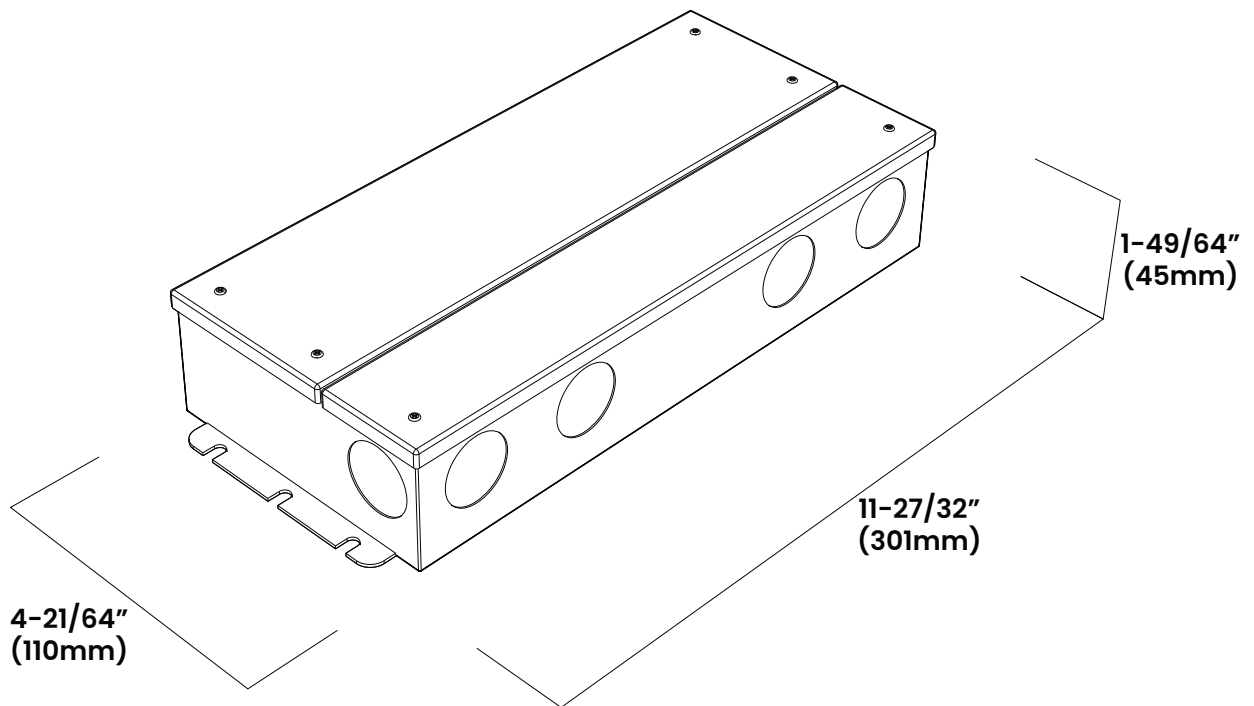

PROJECT

CLIENT

TYPE

Solid State Lighting is sensitive to power fluctuations
Surge protection is highly recommended for all LED lighting products and should be on a designated circuit to protect against premature failure
Lack of surge protection may void your warranty

For more information, please download the
BL LIGHTING catalogue

BL LIGHTING. ILLUMINATE EVERYTHING

111 - 8838 Heather St. Vancouver, BC, Canada, V6P 3S8
P: 1-604-874-4405 F: 1-604-321-0445 E: info@bllighting.com
Copyright © 2017 BL INNOVATIVE LIGHTING. All Rights Reserved.

bllighting.com

