

BL LED DRIVER J5

Standard LED Driver
3x96W, Constant Voltage, 24VDC

3x96W

Printed



Certification



Electrical

Input Voltage	100-277VAC
Input Frequency	47-63 Hz
Max Input Current	3.6A
Output Voltage	24VDC, Constant Voltage
Power	3 x 96W
Min. Power Draw	0W
Dimming	Non-dimmable
Max. Output Current	3 x 4.0A
Connections	16 AWG, Copper Conductors
Power Factor	0.95 - 0.99
Ambient Temperature	-40°F to 140°F (-40°C to 60°C)
Max. Case Temperature	158°F (70°C)
Circuit	Class 2

Mechanical

Housing Construction	Anodized Aluminum
Weight	4.9lb (2.2kg)
Environmental	IP65

PROJECT

CLIENT

TYPE

Solid State Lighting is sensitive to power fluctuations
Surge protection is highly recommended for all LED lighting products and should be on a designated circuit to protect against premature failure
Lack of surge protection may void your warranty

For more information, please download the
BL LIGHTING catalogue

BL LIGHTING. ILLUMINATE EVERYTHING

111 - 8838 Heather St. Vancouver, BC, Canada. V6P 3S8
P: 1-604-874-4405 F: 1-604-321-0445 E: info@bllighting.com
Copyright © 2017 BL INNOVATIVE LIGHTING. All Rights Reserved.

bllighting.com



BL LED DRIVER J5

Standard LED Driver
3x96W, Constant Voltage, 24VDC

3x96W

Printed

Dimensions

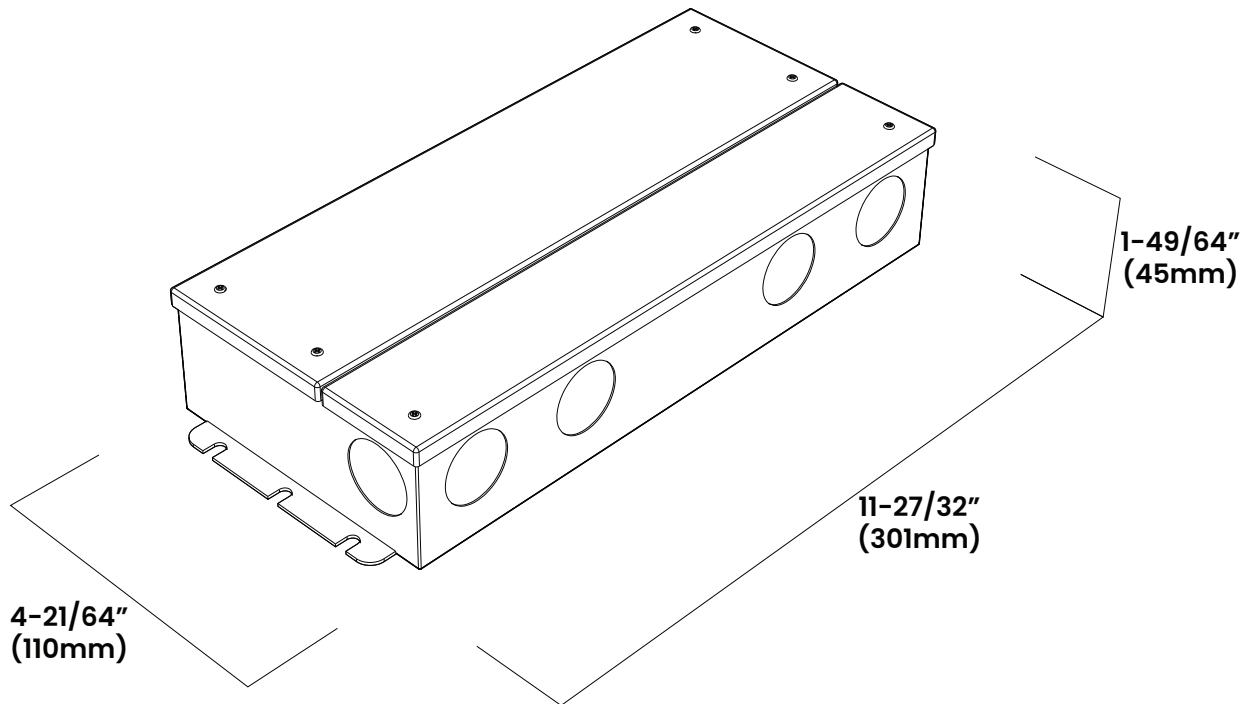

PROJECT

CLIENT

TYPE

Solid State Lighting is sensitive to power fluctuations
Surge protection is highly recommended for all LED lighting products and should be on a designated circuit to protect against premature failure
Lack of surge protection may void your warranty

For more information, please download the
BL LIGHTING catalogue

BL LIGHTING. ILLUMINATE EVERYTHING

111 - 8838 Heather St. Vancouver, BC, Canada, V6P 3S8
P: 1-604-874-4405 F: 1-604-321-0445 E: info@bllighting.com
Copyright © 2017 BL INNOVATIVE LIGHTING. All Rights Reserved.

bllighting.com

